

SediPipe® L | SediPipe® L plus

**Installation and maintenance manual
Stormwater treatment system**

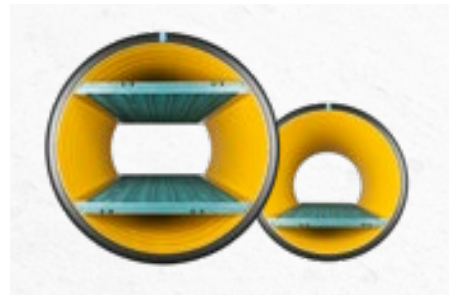
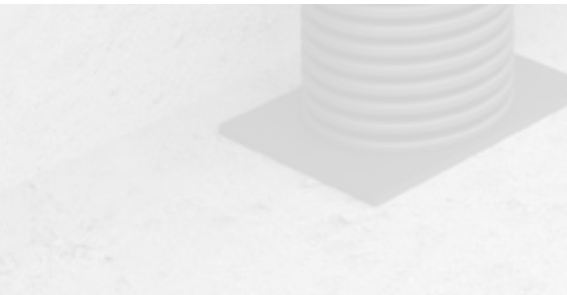

EN | Last modified: May 2018

DRAINAGE SYSTEMS
ELECTRICAL SYSTEMS
BUILDING TECHNOLOGY
INDUSTRIAL PRODUCTS

1. Contact

Professional advice from FRÄNKISCHE

International Sales Director

Horst Dörr +49 9525 88-2490
horst.doerr@fraenkische.de

International Sales

Dinah Nigrowics +49 9525 88-8155
dinah.nigrowics@fraenkische.de

Technology

Stefan Weiß +49 9525 88-8824
stefan.weiss@fraenkische.de

European Sales Director

Klaus Lichtscheidel +49 9525 88-8066
klaus.lichtscheidel@fraenkische.de

European Sales

Jennifer Gernert +49 9525 88-2569
jennifer.gernert@fraenkische.de

Carolin Rausch +49 9525 88-2229
carolin.rausch@fraenkische.de

Jessica Ursin +49 9525 88-2441
jessica.ursin@fraenkische.de

Fax +49 9525 88-2522



Table of contents

1. Contact	2
2. SediPipe L and SediPipe L plus at a glance	4
3. System description	5 - 9
3.1 Application	5
3.2 Function description	5
3.3 SediPipe L and SediPipe L plus system description	6
3.4 Technical data	7
3.5 Installation depths	7
3.6 Overview of the system component sets	8 - 9
4. Installation	10 - 19
4.1 Installation overview - beginning at the start shaft	10
4.2 Installation overview - beginning at the target shaft	11
4.3 Transport and construction site storage	12
4.4 Temporary construction site cover	12
4.5 Excavating pit and creating embedding	13
4.6 Installing the first shaft bottom with inlet or outlet set	13
4.7 Installing the sedimentation path	14
4.8 Installing the second shaft bottom with inlet or outlet set	14
4.9 Creating upper embedding, side filling and cover	15
4.10 Installing extension pipes	15
4.11 Tests before backfilling and impermeability test	15
4.12 Completing cover and creating main backfilling	16
4.13 Cutting extension pipes	16
4.14 Installing shaft covers	17
4.15 Filling the system	18
4.16 Arrangement of multiple SediPipe L systems	18
4.17 Commissioning	19
5. Cleaning	20 - 21
5.1 Emptying and cleaning of the system	20 - 21
5.2 Filling the system with water	21
6. Self-inspection, maintenance and examination	22 - 23
7. Overview - Who does what?	24
8. Safety instructions	27

NB

Please read this installation manual carefully and follow our instructions.

2. SediPipe® L and SediPipe® L plus at a glance

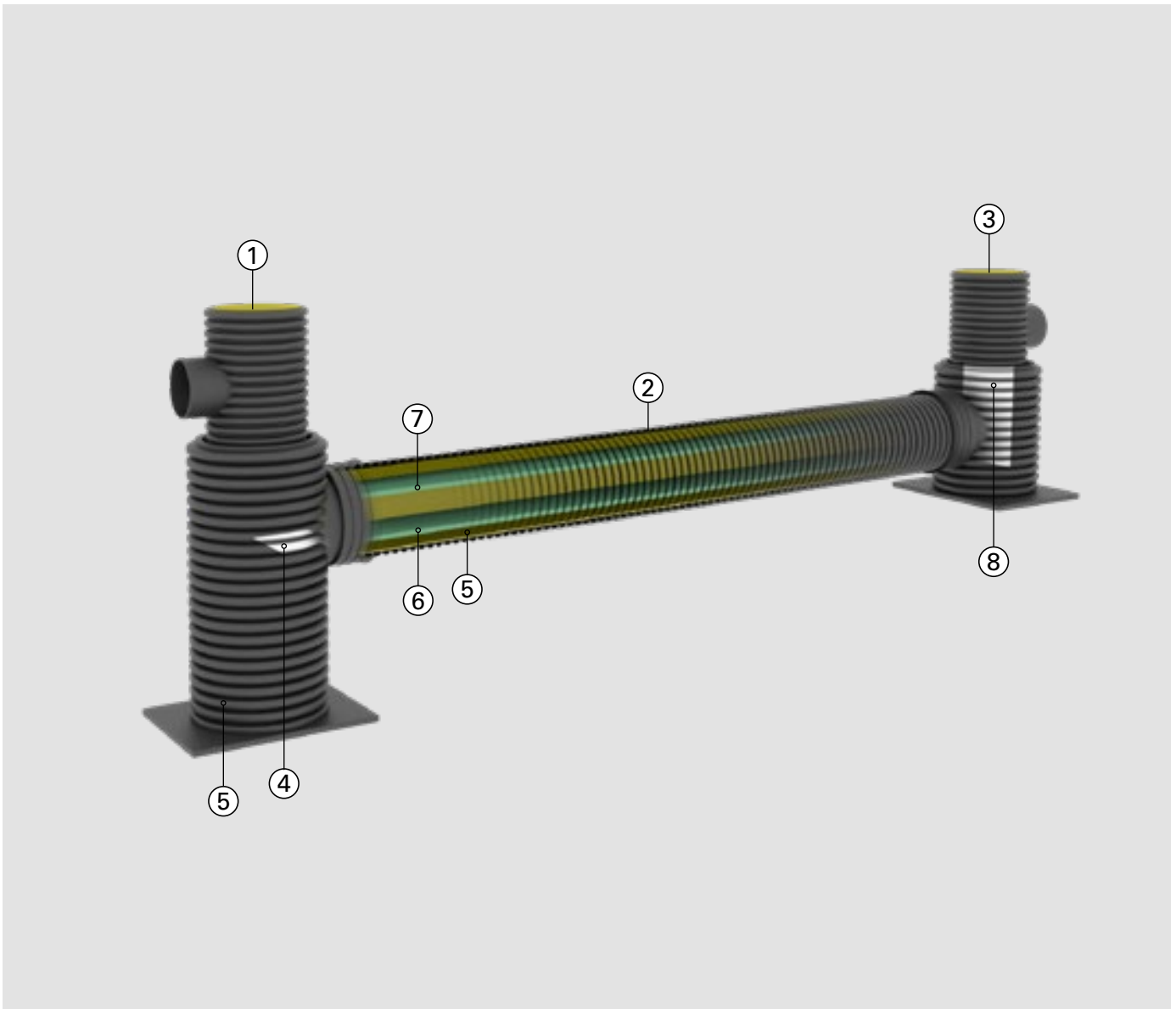

- ① Start shaft
- ② Sedimentation path
- ③ Target shaft
- ④ Maintenance platform
- ⑤ Mud chamber
- ⑥ Flow separator
- ⑦ Flow separator with SediPipe L plus
- ⑧ Immersion wall

3. System description

3.1 Application

SediPipe L and SediPipe L plus are stormwater treatment systems for polluted stormwater runoff, e.g., from traffic areas. The systems separate washed-up particles and light liquids (oil) from

stormwater and reliably retain these materials in the system, even in case of spills in dry weather.

3.2 Function description

SediPipe L and SediPipe L plus are stormwater treatment systems which keep a permanent water level. Sedimentation initially retains the coarse particles in the start shaft. The upstream sedimentation path retains fine particles. The lower flow

separator prevents remobilisation and therefore discharge of sediment also during heavy rain. Systems of the SediPipe L plus type additionally feature an upper flow separator leading to increased separation performance for light liquids in rainfall events.

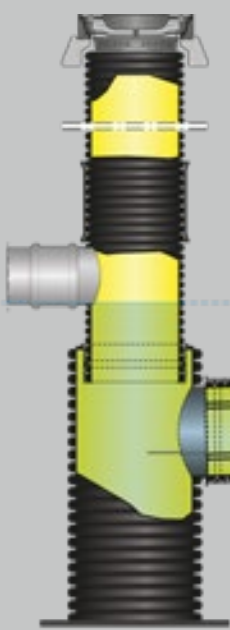
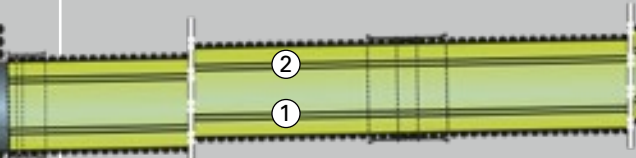
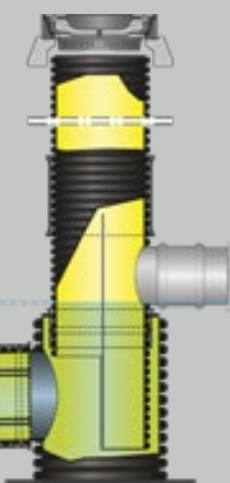
Start shaft	Sedimentation path		Target shaft
			
Retention of coarse particles	<ul style="list-style-type: none"> ① Retention of fine particles ② Separation of light liquids (SediPipe L plus) 		Retention of light liquids
Sedimentation (physical)	Sedimentation (physical)	Sediment control thanks to flow separator	Immersion wall (physical)

3. System description

3.3 SediPipe L and SediPipe L plus system description

Systems of the SediPipe L and SediPipe L plus design are comprised of a start shaft, a target shaft and a sedimentation path.

The shafts are delivered as a three-piece push-fit system and comprise

a shaft bottom with a factory-welded base plate, an inlet and/or outlet set and an extension pipe which can be cut to length individually. The sedimentation path is comprised of one or several main pipes. The total length of the sedimentation path depends on

the system type and varies between 6 m and 24 m. The target shaft features an immersion wall. The sedimentation path features a construction-related slope when installed.



Section SediPipe L plus 600/12

Start shaft components:

- ① Shaft bottom DN 800 with base plate
- ①a With maintenance console
- ② Inlet set DN 600 with connection DN/OD 315 and/or DN/OD 400, incl. coupling DN 600 and sealing rings
- ③ Extension pipe DN 600
- ④ Class D BARD ring
- ⑤ Cover CW 610 with ventilation openings (to be supplied on site)

Sedimentation path, components:

- ⑥ Sedimentation pipe(s) DN 600 with flow separator(s), installation length of 6 m each
- ⑦ Coupling(s) and sealing rings

Target shaft, components:

- ⑧ Shaft bottom DN 800 with base plate
- ⑨ Outlet set DN 600 with connection DN/OD 315 or DN/OD 400, incl. coupling DN 600 and sealing rings
- ⑩ Extension pipe DN 600
- ⑪ Class D BARD ring
- ⑫ Cover CW 610 with ventilation openings (to be supplied on site)

3. System description

3.4 Technical data

SediPipe L / SediPipe L plus	600/6	600/12	600/18	600/24
Length L [m]	6.10	12.12	18.17	24.22
Length L ₁ [m]	7.03	13.05	19.10	25.15
Height of inlet H _{Inlet} [m]	≤3.79	≤3.79	≤3.79	≤3.79
Height of outlet H _{Outlet} [m]	≤4.74	≤4.74	≤4.74	≤4.74
DN sedimentation path [mm]	600	600	600	600
Length of the sedimentation path [m]	6	12	18	24
Sedimentation path slope [%]	4.0	2.0	1.3	1.0
Sedimentation path slope as angle α	2.3°	1.1°	0.8°	0.6°
Collecting volume of light liquids * [litres]	1990	3270	4560	5860
Collecting volume of the mud chamber [litres]	770	970	1180	1390
Permanent water level volume [litres]	3240	4920	6600	8280
Sedimentation pipe material	PP	PP	PP	PP
Shaft material	PP	PP	PP	PP

* retention of light liquids in case of spills in dry weather

3.5 Installation depths

The stability of the system has been proven by standard statics. The maximum installation depth of the shafts from the top edge of terrain to the shaft bottom, also in case of groundwater, is 6 m depending on installation parameters (soil temperature lower than or equal to 23°).

The minimum depth of the system derives from the minimum required

distance between the pipe crown, inlet and/or outlet channel and the bottom edge of the BARD ring of 35 cm. With a conventional class D cover without equalisation ring this corresponds to an inlet channel soil depth of 1.02 m for a DN/OD 315 connection. Connections DN/OD 400 correspond to an inlet channel soil depth of 1.10 m.

3. System description

3.6 Overview of the system component sets

In the ordering process, each system is comprised of two sets and the covers CW 610 with ventilation openings to be supplied on site.

The first set is the SediPipe system,

the second set includes the connections to the sewer. The sets are available in different designs to ideally adapt the complete system to the project-specific requirements. You can

select as follows depending on the desired system size, installation depth, nominal diameter and number of inlets.

Set 1: SediPipe L / SediPipe L plus basic set

System size	600/6		600/12		600/18		600/24	
	SediPipe L	SediPipe L plus	SediPipe L	SediPipe L plus	SediPipe L	SediPipe L plus	SediPipe L	SediPipe L plus
Basic set								
Cat. no.	515.97.806	515.97.906	515.97.812	515.97.912	515.97.818	515.97.918	515.97.824	515.97.924
	pc(s).	pc(s).	pc(s).	pc(s).	pc(s).	pc(s).	pc(s).	pc(s).
Shaft bottom start shaft DN 800 with base plate; connection 1x DN 600; approx. 2.0 m total height; labelling: "Start shaft bottom SediPipe L oSS L"	1	-	1	-	1	-	1	-
Shaft bottom start shaft DN 800 with base plate; connection 1x DN 600; approx. 2.0 m total height; labelling: "Start shaft bottom SediPipe L plus"	-	1	-	1	-	1	-	1
Sedimentation pipe DN 600 with lower flow separator, 6 m installation length each	1	-	2	-	3	-	4	-
Sedimentation pipe DN 600 with lower and upper flow separator, 6 m installation length each	-	1	-	2	-	3	-	4
Coupling DN 600	0		1		2		3	
Profile sealing ring DN 600	2		4		6		8	
Tubes of lubricant, 500 ml	2		3		4		5	
Shaft bottom target shaft DN 800 with base plate; connections 1x DN 600, approx. 1.2 m total height; labelling: "Target shaft bottom SediPipe L / L plus"	1		1		1		1	



3. System description

Set 2: SediPipe L / SediPipe L plus connection set

Inlet channel soil depth	up to 2.5 m			greater than 2.5 m (*)		
Inlet and outlet connection	DN/OD 315	DN/OD 400	Inlets DN/OD 400 and 2x DN/OD 315 and outlet DN/OD 400	DN/OD 315	DN/OD 400	Inlets DN/OD 400 and 2x DN/OD 315 and outlet DN/OD 400
Cat. no.	515.97.850	515.97.860	515.97.855	515.97.851	515.97.861	515.97.856
	pc(s).	pc(s).	pc(s).	pc(s).	pc(s).	pc(s).
Inlet set DN 600 with connection DN/OD 315, incl. coupling DN 600 with sealing ring	1	-	-	1	-	-
Inlet set DN 600 with connection DN/OD 400, incl. coupling DN 600 with sealing ring	-	1	-	-	1	-
Inlet set DN 600 with connections DN/OD 400, DN/OD 315 and DN/OD 315, incl. coupling DN 600 with sealing ring	-	-	1	-	-	1
Extension pipe DN 600, 1.6 m length	2	2	2	-	-	-
Extension pipe DN 600, 2.9 m length	-	-	-	1	1	1
Extension pipe DN 600, 3.8 m length	-	-	-	1	1	1
Class D BARD ring	2	2	2	2	2	2
Outlet set DN 600 with connection DN/OD 315, incl. coupling DN 600 and sealing ring	1	-	-	1	-	-
Outlet set DN 600 with connection DN/OD 400, incl. coupling DN 600 and sealing ring	-	1	1	-	1	1
Profile sealing ring DN 600	4	4	4	4	4	4
Lubricant, 500 ml	3	3	3	3	3	3

*) Max. soil depth from Chapter 3.4 "Height of inlet H_{inlet} [m]" and "Height of outlet H_{outlet} [m]"



4. Installation

Depending on on-site conditions, installation of the system can begin either at the start shaft or at the target shaft:

Supply pipe available:
begin at start shaft
Chapter 4.1

Drainage pipe or storage/infiltration system available:
begin at target shaft
Chapter 4.2

4.1 Installation overview - beginning at the start shaft



Start shaft bottom with inlet set
Chapter 4.6



Sedimentation path
Chapter 4.7



Target shaft bottom with outlet set
Chapter 4.8



Extension pipes and covers
Chapter 4.10
Chapter 4.13
Chapter 4.14

4. Installation

4.2 Installation overview - beginning at the target shaft



Target shaft bottom with outlet set
Chapter 4.6



Sedimentation path
Chapter 4.7



Start shaft bottom with inlet set
Chapter 4.8



Extension pipes and covers
Chapter 4.10
Chapter 4.13
Chapter 4.14

4. Installation

4.3 Transport and construction site storage

The components must be specifically prepared for transport and lifting. Use one or two wide hoisting slings or round slings for this purpose.

The heaviest component is the shaft base element of the start shaft, weighing 200 kg.

ATTENTION

Store all components on plain ground using sleepers and secure against shifting. Damaged parts must NOT be installed. Do NOT throw components!

Only install and lift components at temperatures above freezing point.



Storage on sleepers



4.4 Temporary construction site cover

The shaft bottoms and extension pipes are delivered with temporary construction site covers.

Make sure that no dirt, e.g., backfill material, enters the system during the

construction period. Do NOT remove the temporary construction site covers before installing extension pipes and/or shaft covers. Additionally protect shaft openings from earth slides until final installation of shaft covers.

ATTENTION

Shafts must NOT be accessed before installing the cover. If necessary, the required load transfer to the native soil must be ensured, e.g., using a wide steel plate.

4. Installation

4.5 Excavating pit and creating embedding

In addition to the regulations of DIN EN 1610, observe the specifications of DIN 18300 "Earthworks" (*Erdarbeiten*) in the latest version regarding excavating the pit and creating the lower embedding of the start and target shaft and the sedimentation path. If the native soil is not made up of stoneless, compactable material G1 (GE, GW, GI, SE, SW, SI) or G2 (GU, GT, SU, ST), create an embedding according to DIN EN 1610. You generally have to

create the embedding with a consistent degree of compaction of $D_{pr} \geq 95\%$ and a load-bearing capacity of $E_{v2} \geq 45 \text{ MN/m}^2$.

The minimum widths according to DIN EN 1610 must be strictly adhered to when creating pipe swales. Please observe any deviating minimum widths in the area of the shafts according to local specifications.

ATTENTION

The bearing heights of start shaft and target shaft and the required height difference must be created according to design specifications.

4.6 Installing the first shaft bottom with inlet or outlet set

Place the shaft bottom at the appropriate height on the prepared planum and secure it to prevent shifting. Make sure no backfill material enters the shaft (use temporary construction site cover).

Connect the supply pipe and drainage pipe according to design specifications. Remove the shaft bottom's temporary construction site cover and subsequently place it on the coupling of the

inlet or outlet set. Install the set in the top coupling of the first shaft bottom. The coupling factory-mounted to the connection pipe for later installation of the extension pipe is at the top.

Turn the connecting tee to establish the inlet and outlet angle. The direction of the inlet and outlet channel defines the rotational direction of the connection set. The following connection angles are possible:

ATTENTION

The crown markings of pipe and coupling must match exactly for all pipe installations!

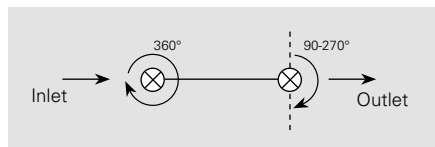

Plan: admissible angle of inlet and outlet

4. Installation

4.7 Installing the sedimentation path

1. Mount profile sealing rings onto the first corrugation trough on each side while still outside the excavation pit.
The pipe must be clean.
2. Move the sedimentation pipe to the installation position using lifting equipment. The crown marking must face upwards! The integrated flow separator faces downwards! SediPipe L plus features one upper and one lower flow separator.
3. Keep the pipe, sealing ring and the coupling clean. Apply a sufficient amount of lubricant to the sealing ring and coupling.

Ensure that the sealing area is free of dirt. Deepen the embedding in the area of the couplings as required. In order to prevent the profile sealing ring from resting on the bearing, the pipe end to be installed can rest on square timber.

4. Use a long lever to install the pipe. Place a board or square timber under the unattached pipe end to prevent damage to the pipe. Pipes must be installed horizontally. Mark the insertion depth on the pipe beforehand. Afterwards, create the pipe slope by aligning the pipe. When completing the lower

embedding by means of tamping, make sure that the bottom side of the pipes rests completely on the compacted foundation.

5. Secure the pipes to prevent shifting during installation.

ATTENTION

The crown marking of the pipe section must face upwards. The flow separators of the individual sedimentation pipes then form an overall consistently level surface.



Installation of sealing ring onto sedimentation pipe



Sealing ring with lubricant



Installation of sedimentation pipe

4.8 Installing the second shaft bottom with inlet or outlet set

Place the second shaft bottom at the appropriate height on the prepared planum. Afterwards, prepare the coupling connection and mount the shaft onto the sedimentation pipe.

Connect the supply pipe and drainage pipe according to design specifications. Remove the shaft bottom's temporary construction site cover and subsequently place it on the coupling of the

inlet or outlet set. Install the set in the top coupling of the first shaft bottom. The coupling factory-mounted to the connection pipe for later installation of the extension pipe is at the top.

Turn the connecting tee to establish the inlet and outlet angle. The direction of the inlet and outlet channel defines the rotational direction of the connection set.

The following connection angles are possible:

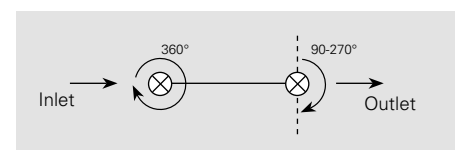

Plan: admissible angle of inlet and outlet

4. Installation

4.9 Creating upper embedding, side filling and cover (up to the top edge of the shaft bottom)



Compacting of lateral backfilling

The specifications of the latest version of DIN EN 1610 must be adhered to when creating the upper embedding, side filling and cover up to the top edge of the shaft bottom.

If country-specific regulations or deviating specifications conflict with this, these must be agreed upon with FRÄNKISCHE.

Fill the backfilling with stoneless, compactable material G1 (GE, GW, GI, SE, SW, SI) or G2 (GU, GT, SU, ST) according to

DIN EN 1610 and create a consistent degree of compaction of $D_{pr} \geq 95\%$ and a load-bearing capacity of $E_{v2} \geq 45 \text{ MN/m}^2$.

Make sure that the shafts and sedimentation pipes do not shift during backfilling of the excavation pit.

ATTENTION

Do NOT remove temporary construction site covers or protective covers before finishing main backfilling!

4.10 Installing extension pipes

Now, place the extension pipes over the couplings DN 600. Keep the pipe, sealing ring and the coupling clean. The sealing rings are mounted onto the second corrugation trough.

Apply a sufficient amount of lubricant to the sealing ring and coupling. Ensure that the sealing area is free of dirt.



4.11 Tests before backfilling and impermeability test

Before backfilling the excavation pit, check the system for proper installation and leak-tightness.

The following tests must be performed in particular:

- | | | | |
|--|-------------------------------------|---|-------------------------------------|
| 1 Height of the shafts according to design specifications | <input checked="" type="checkbox"/> | 5 Total insertion depth at the couplings. | <input checked="" type="checkbox"/> |
| 2 Exact adjustment of the shafts | <input checked="" type="checkbox"/> | 6 Position and matching of crown markings (top). | <input checked="" type="checkbox"/> |
| 3 Check for damage, foreign objects or coarse contamination | <input checked="" type="checkbox"/> | 7 Impermeability test | <input checked="" type="checkbox"/> |
| 4 Axial direction of the system | <input checked="" type="checkbox"/> | | |

Tip

We recommend having the system approved by the site management before backfilling.

4. Installation

4.12 Completing cover and creating main backfilling

Backfilling work is finished after installing the extension pipes. Provide a soil cover of at least 30 cm for the sedimentation path. The materials for main backfilling must be filled and compacted according to design spec-

ifications. Make sure that the shafts and sedimentation pipes do not shift during backfilling of the excavation pit. Accessing is only permitted after main backfilling has been completed.

ATTENTION

Do NOT remove the temporary construction site covers or protective covers of the extension pipes before finishing main backfilling!

4.13 Cutting extension pipes

Cut the extension pipes such that they reach the support ring. Cut the pipes to length in the middle of the corrugation trough and align upright to the pipe axis using a fine-toothed saw or other appropriate tools. Remove edges and irregularities on the cutting surfaces with a grater, file or another suitable tool.

You might have to cut the coupling as well in case of minimum covers. The BARD ring has a sufficient diameter and can be pushed over the coupling.



NB

Height adjustment extension pipe per corrugation crown ~7 cm

4. Installation

4.14 Installing shaft covers

The BARD ring (class D concrete support ring by FRÄNKISCHE) transfers traffic loads into the soil.

There must be no direct load transfer between BARD ring and shaft. The bedding area of the BARD ring must be flat and without stationary loads, and it must achieve an E_{v2} module of at least 100 MN/m^2 . Create the bearing from compacted bearing layer material (E_{v2} module $\geq 100 \text{ MN/m}^2$) or in-situ concrete C 16/20 with similar load-bearing properties. Avoid interlocking of the bearing with the corrugations of the extension pipe. Provide and use a casing aid on site! Vertical loads may only be transferred to the load-bearing under-

ground. The BARD ring must be placed centrally without affecting the bearing.

Shaft covers, equalisation rings, gully gutters, bucket handles and buckets are not included in the scope of delivery of FRÄNKISCHE Rohrwerke and must be supplied on site.

Install shaft covers according to DIN EN 124, CW 610, installation according to design specifications. Optionally, place equalisation rings according to DIN 4034 under the shaft cover/gully gutter on the BARD ring. The shaft cover and/or equalisation ring(s) must be placed on a 10-mm-thick mortar joint to

prevent stationary loads between the BARD ring, the equalisation ring and the shaft cover.

Use common dirt traps under the shaft covers. If the start shaft must feature a gully gutter according to design specifications, a bucket handle (or feed hopper) and a bucket according to DIN 4052-A4 must be installed.

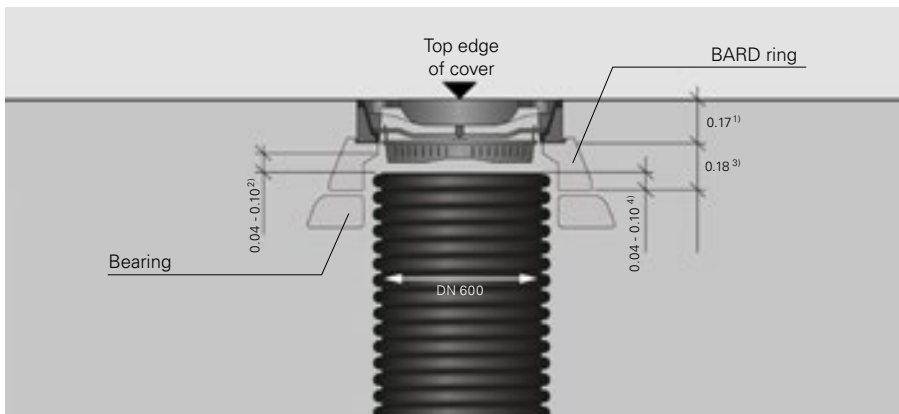

- 1) Height of shaft cover incl. 1 cm mortar joint. The dimension is variable, depending on class B or D shaft cover and use of additional support rings (incl. mortar joint to ensure a bearing without stationary loads)
- 2) Compensating area: 4 cm to 10 cm
- 3) BARD ring, inside \varnothing 745 mm, h = 180 mm
- 4) Insertion area: Extension pipe in BARD ring 4 cm to 10 cm, height adjustment in the insertion area accurate to within the last centimetre possible



NB

Height adjustment extension pipe per corrugation crown ~7 cm

4. Installation

4.15 Filling the system

After the work has been completed, the system must be filled with water up to the permanent water level. This is required to ensure the retention of floatables and light liquids by the immersion wall. The system must be

filled with water (e.g., drinking water, service water, from water recovery or treated wastewater from system cleaning) complying with the local discharge conditions.

NB

For permanent water level volume, see Chapter 3.4

4.16 Arrangement of multiple SediPipe L systems

The above sections of the installation manual describe the standard installation as individual system. The following describes the recommendations for the arrangement of multiple systems and the required minimum distances.

We draw your attention to the fact that for installation clearances between distribution and combining units and the treatment system, the respective fitting dimensions of the connection pipes and their space requirements must be considered for the installation in addition to the general minimum clearances specified by standards.

ATTENTION

Make sure that the system components are not damaged during backfilling or compacting. Observe the installation instructions for individual systems.

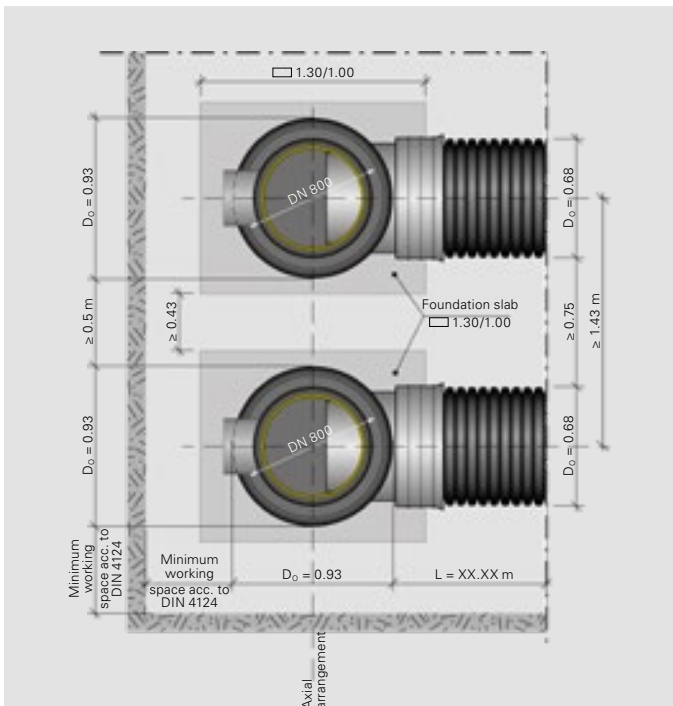

Axial arrangement

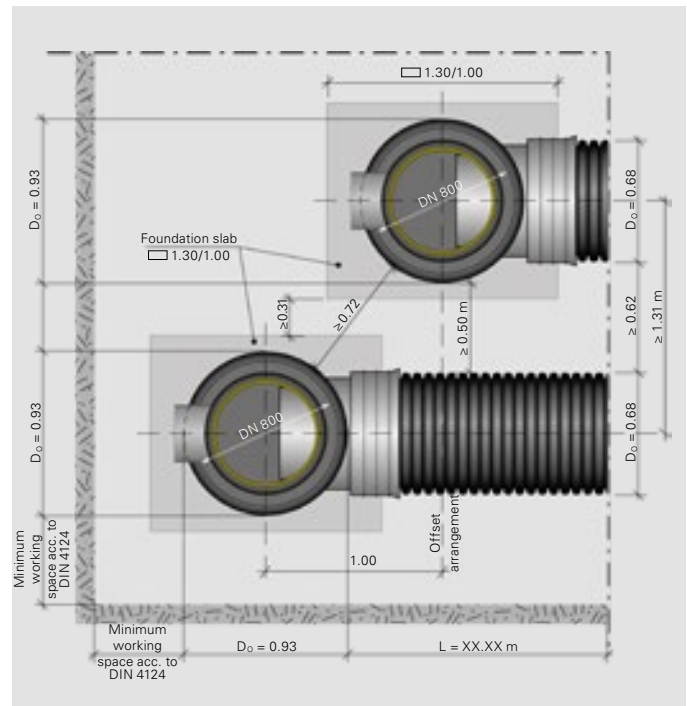

Offset arrangement

4. Installation

4.17 Commissioning

ATTENTION

Observe the safety instructions (page 27).

1 Making system ready for operation

- Clean system of coarse dirt
- Remove auxiliary constructions
- Fill system with water
- Close shaft covers



2 Instruction

1. The following people should be present during instruction:

- Persons authorised by the principal to perform the acceptance
- Planner/engineering office
- Construction contractor
- Specialist/expert

We also recommend participation of operating staff.



2. Instruction

- Explain function of system
- Explain maintenance
- Information regarding cleaning and disposal
- Information about FRÄNKISCHE partner companies



3 Documentation/handling over

- Hand over maintenance and installation manuals
- Hand over system documentation including operating log
- Proof of system leak tightness
- Optionally: documentation of thorough visual inspection



5. Cleaning

5.1 Emptying and cleaning of the system

All the emptying and cleaning work of the system described in this section must generally be made without accessing the shafts.

Use a high-pressure cleaning/vacuum vehicle to empty the system and remove the contained water and mud

fractions. To do so, initially vacuum the complete contents through the shaft. The valve flap sealing the mud chamber of the sedimentation pipe can now be moved freely.

Due to the slope of the sedimentation pipe, most of its mud collector will be emptied of its contents into the start shaft.

ATTENTION

In the event of an oil spill, the system must be immediately maintained by a specialist and the washed matter must be disposed of appropriately! Otherwise, subsequent rain may lead to a discharge of light liquids!

Step 1: Emptying with vacuum hose

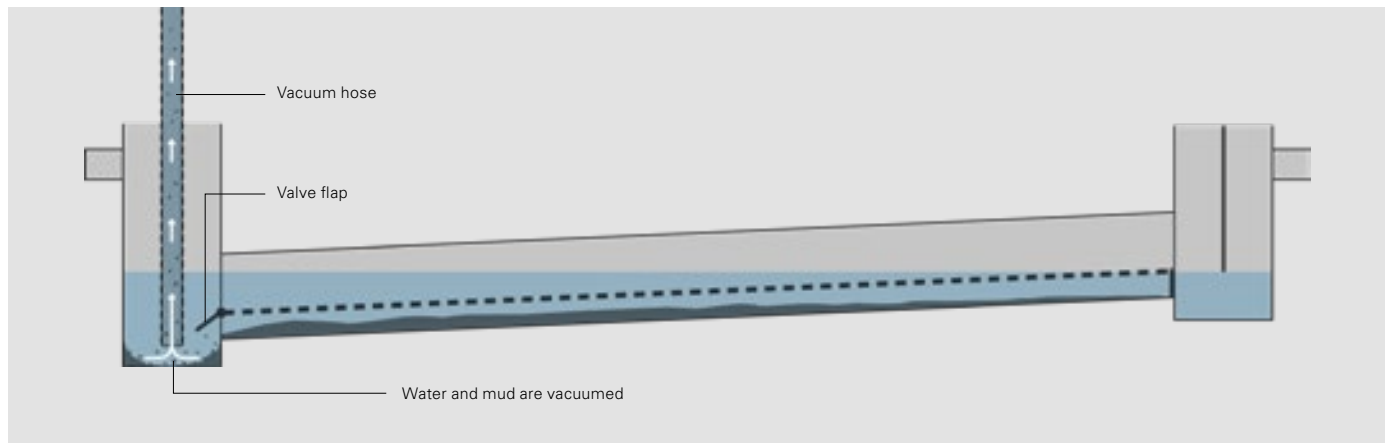

5. Cleaning

When empty, the maintenance console mounted at the height of the flow separator is visible in the start shaft. The maintenance console facilitates inserting and guiding the flush hose during high-pressure cleaning.

The flush hose is guided through the maintenance console on the flow separator. The cleaning nozzle is guided up to the target shaft during high-pressure cleaning. Make sure that the nozzle does

not enter the target shaft. The efficiency of the vehicle and the cleaning and nozzle parameters must be selected depending on the pipe section, pipe material and degree of pollution to be expected.

Use deflection pulleys to avoid damage to the system.

Afterwards, empty the target shaft using the vacuum hose. If necessary, clean the shaft using high-pressure jetting.

Tip

Combined flushing-vacuum vehicles with water recovery should be used preferably. This minimises disposal expenses and the treated water can be used to refill the system.

Step 2: Cleaning with vacuum and flush hose

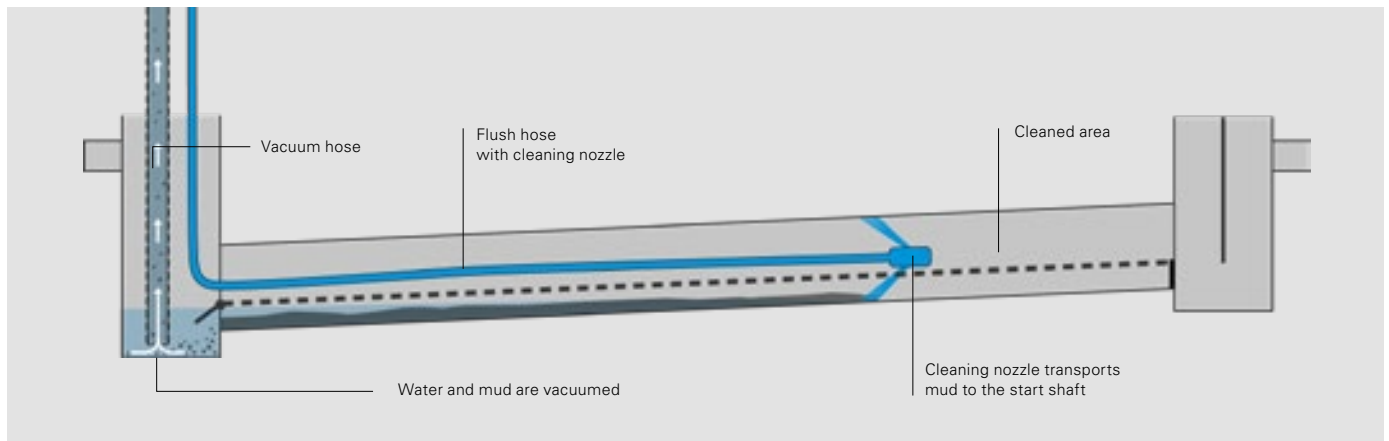

5.2 Filling the system with water

After the work has been completed, the system must be filled with water up to the permanent water level. This is required to ensure the retention of floatables and light liquids through the immersion wall.

The system must be filled with water (e.g., drinking water, service water, from water recovery or treated wastewater from system cleaning) complying with the local discharge conditions.

NB

For an illustration, see Chapter 3.3, page 6, for permanent water level volume, see Chapter 3.4 Technical data, page 7

6. Self-inspection, maintenance and examination

6.1 General information

To ensure functionality of the SediPipe L/ SediPipe L plus system, its condition must be ensured through recurring self-inspections and maintenance. All work and findings must be documented in the operating log. We generally

recommend entering a maintenance agreement with an expert (FRÄNKISCHE partner company). Please see www.fraenkische.com for an overview of partner companies trained by FRÄNKISCHE.

ATTENTION

The respective periods and responsibilities are only a recommendation by FRÄNKISCHE and may differ from authority approvals. In these cases, the authorities' requirements are mandatory and must be observed!

6.2 Self-inspection

The operational capability of the system must be verified by the operator under dry weather conditions at least every three months. To do so, open the covers of the start and target shafts and visually inspect from the top without accessing the shafts themselves (simple visual inspection).

Check the following:

- structural condition of the system
- height of the permanent water level
- mud level of the start shaft

ATTENTION

If a relevant deviation from normal conditions occurs which may impair the operational capability of the system, maintenance must be carried out in order to immediately eliminate the detected deficiencies.

6.3 Maintenance

Until there are no system-specific empirical values regarding the actual volume of mud, the SediPipe system must be maintained according to the following guiding values. Maintenance comprises cleaning only.

The following work must be performed:

- emptying and cleaning of the system (see Chapter 5.1, page 20 et seq.)
- refilling the system (see Chapter 5.2, page 21)

Tip

Operators can schedule the system-specific maintenance interval as described in the following to reduce operating costs or in case of special areas with increased mud volumes:

Provided that the complete system was cleaned after finishing construction, emptying and cleaning of SediPipe can take place depending on the mud level. To do so, measure the mud level in the start shaft during self-inspection. We recommend emptying when 80 % of the mud storage volume or the maximum mud level in the start shaft have been reached. The storage volume can be obtained from the table (see Chapter 3.4, page 7).

Type of system	Maintenance interval 1 year	Maintenance interval 2 years	Maintenance interval 3 years	Maintenance interval 4 years
	connectable area [m ²]	connectable area [m ²]	connectable area [m ²]	connectable area [m ²]
SediPipe L / L plus 600/6	21,450	10,700	7,150	5,350
SediPipe L / L plus 600/12	27,200	13,600	9,050	6,800
SediPipe L / L plus 600/18	33,000	16,500	11,000	8,250
SediPipe L / L plus 600/24	38,800	19,400	12,900	9,700

Basis average volume of pollution 500 kg/ha*a (dry matter)

6. Self-inspection, maintenance and examination

6.4 Disposal

Materials removed from the system such as mud and flushing water used to clean the system may contain hydrocarbons and heavy metals. Therefore, they must be disposed of in compliance with the applicable legal provisions. Waste fractions occurring after spills with light liquids must be disposed of professionally as "oil/water separator

contents" in compliance with the current waste catalogue. The statutory disposal and acceptance certificates must be included in the operating log together with the entries as evidence of proper disposal.

ATTENTION

Applicable waste disposal regulations must be observed when disposing of the system.

6.5 Thorough visual inspection

The structural condition of the sedimentation path can be inspected by thorough visual inspection using CCTV inspection. To this end, the upper flow area is accessed with a state-of-the-art pan and tilt camera. The lower sedimentation

chamber can be inspected visually through the flow separator.

Here, the maintenance console facilitates inserting the dolly and guiding the camera cable. Use appropriate deflection pulleys.

Inspection equipment should be selected according to DWA worksheet and bulletin series DWA-A/M 149 "Conditions and Assessment of Drain and Sewer Systems Outside Buildings" and should be adjusted to pipe section and pipe material.



Inspection of flushing results with pan and tilt camera, camera on the maintenance console in the start shaft of a SediPipe L system



Cleaned, residue-free system, here in the area of the flow separator

7. Overview - Who does what?

	Who	What	When	Documentation
Installation	Specialist	<ul style="list-style-type: none"> - Installation, cleaning and CCTV inspection of the system - Filling the system with water from water recovery or with water complying with the local discharge conditions 		Operating log
Self-inspection	Operator	<ul style="list-style-type: none"> Simple visual inspection - Structural condition of the system - Height of the permanent water level - Mud level of the start shaft 	at least every 3 months	Operating log
Maintenance	Specialist	<ul style="list-style-type: none"> - Emptying and cleaning of the entire system using sewer cleaning vehicle - Refilling the system with water from water recovery or with water complying with the local discharge conditions - Disposal of mud and solids - Applicable waste disposal regulations must be observed. 	right after oil spill, otherwise see guiding values in the maintenance documentation	Operating log
Disposal	Specialist/waste disposal company	<ul style="list-style-type: none"> - Disposal of mud and solids - Applicable waste disposal regulations must be observed. 	when the retention volume has been used up	Operating log Disposal certificates
Repairs	Specialist	Original parts or tailored parts explicitly approved by the manufacturer may be used only.	as required	Operating log

8. Safety instructions

ATTENTION

Staff responsible for installation, assembly, operation, maintenance and repair must have appropriate qualifications required for this kind of work. The builder is responsible for organising in detail authority, responsibility and supervision of staff.

The operational safety of the system components supplied is only guaranteed in case of proper installation and correct use. Technical threshold values must not be exceeded.

Observe the accident prevention regulations and relevant standards and directives for installation, fitting, operation, maintenance and repair!

This includes (in extracts):

- Accident prevention regulations
 - Construction work BGV C22
 - Technical wastewater systems GUV-V C5
- Safety regulations for working in enclosed spaces of technical wastewater systems GUV-R 126
- Handling biological working materials in technical wastewater systems GUV-R 145
- Directives for working in tanks and narrow spaces BGR 117
- Standards
 - Excavations and trenches - slopes, planking and strutting, breadths of working spaces DIN 4124
 - Construction and testing of drains and sewers DIN EN 1610
- Tool for safety and health protection in technical wastewater systems.



- Hazards from gases and vapours such as risk of suffocation, risk of poisoning and risk of explosion
- Risk of falling
- Risk of drowning

- Germ pollution and wastewater with sewage
- High physical and psychic strain during work in deep, narrow and dark spaces
- and others



Non-compliance with the operating manual may result in considerable

property damage, injury or death.



The system is part of an entire network. During installation, maintenance, service and repair work on one component, always consider the entire system. Avoid work during rain.

Changes or modifications to the system may only be carried out with the agreement of the manufacturer. For safety reasons, use original spare parts and accessories approved by the manufacturer. The use of other parts voids the liability for any consequences arising therefrom.

General information on using our products and systems:

Information about or assessments of the use and installation of our products and systems is exclusively provided on the basis of the information submitted. We do not assume any liability for damage caused by incomplete information. If the actual situation deviates from the planned situation or if a new situation occurs or if different or new installation techniques are applied, these must be agreed upon with FRÄNKISCHE, since these situations or techniques may lead to different conclusions. Notwithstanding the above, the customer is solely responsible for verifying the suitability of our products and systems for the intended purpose. In addition, we do not assume any liability or responsibility for system characteristics and system functionalities when third-party products or accessories are used in combination with FRÄNKISCHE systems. We only assume liability if original FRÄNKISCHE products are used. For use in other countries than Germany, country-specific standards and regulations must also be observed.

All information in this publication generally reflects the state of the art at the time of printing. Furthermore, considerable care was taken when preparing this publication. Nevertheless, typesetting and translation errors cannot be entirely excluded. We also reserve the right to make changes to our products, specifications and other data. Changes may also become necessary as a result of legal, material-related or other technological requirements, which cannot or can no longer be considered in this publication. For this reason, we cannot assume any liability which is based solely on the data provided in this publication. The decisive role with regard to the data on products and services is always played by the order placed, the product actually purchased and the documentation in connection with it, or the information provided by our specialist staff in each specific individual case.

Rooted in Königsberg – globally successful!

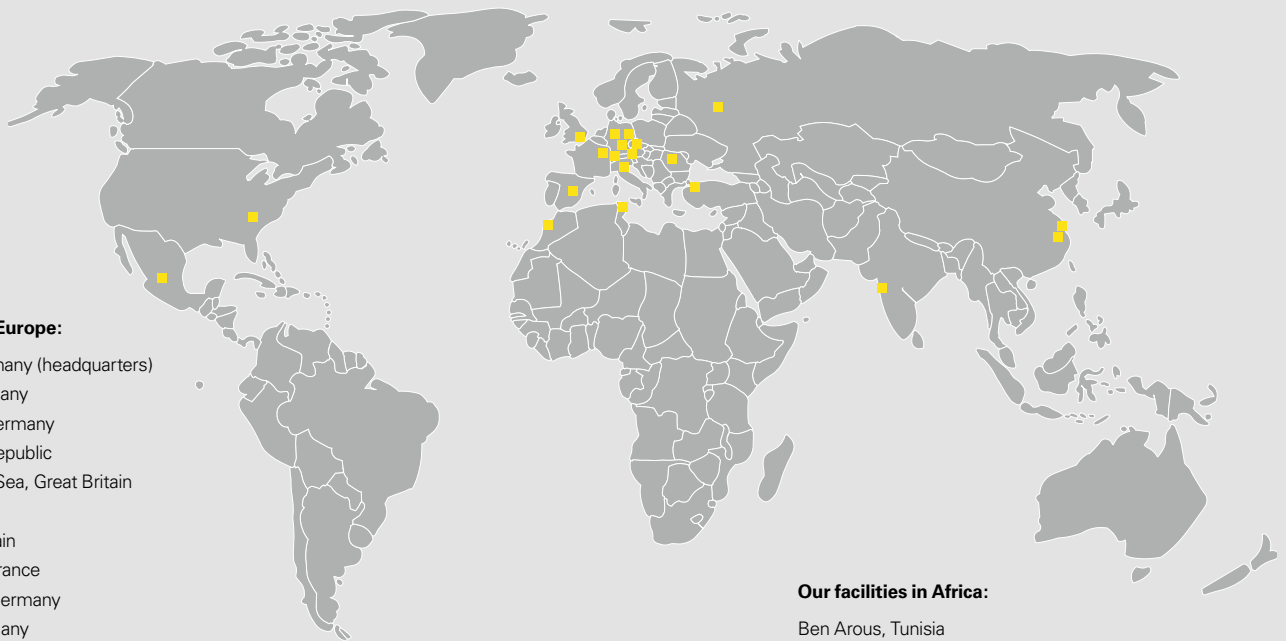

Our facilities in Europe:

Königsberg, Germany (headquarters)
 Bückeberg, Germany
 Schwarzheide, Germany
 Okříšky, Czech Republic
 St.-Leonards-on-Sea, Great Britain
 Moscow, Russia
 Yeles/Toledo, Spain
 Torcy-le-Grand, France
 Ebersbach/Fils, Germany
 Hermsdorf, Germany
 Mönchaltorf, Switzerland
 Milan, Italy
 Istanbul, Turkey
 Cluj, Romania
 Wels, Austria

Our facilities in Asia:

Anting/Shanghai, China
 Hangzhou, China
 Pune, India

Our facilities in Africa:

Ben Arous, Tunisia
 Casablanca, Morocco

Our facilities in North America and Mexico:

Anderson, USA
 Guanajuato, Mexico

FRÄNKISCHE is an innovative, growth-oriented, medium-sized family-owned enterprise and industry leader in the design, manufacturing and marketing of technically superior corrugated pipe systems for drainage, electrical, building technology and industrial applications.

We currently employ about 4,200 people worldwide. Both our many years of experience and expertise in plastics pro-

cessing, our consulting services and the large array of products are highly valued by our customers.

FRÄNKISCHE is a third generation family owned business that was established in 1906 and is now run by Otto Kirchner. Today, we are globally represented with production facilities and sales offices. The proximity to our customers enables us to develop products and solutions

that are perfectly tailored to our customers' needs. Our action and business philosophy focus on our customers and their needs and requirements for our products.

FRÄNKISCHE – Your partner for sophisticated and technologically advanced solutions.